

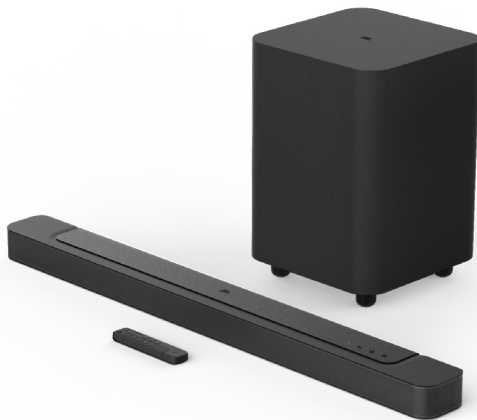

QUICK START GUIDE

BAR 500







Before using this product, read the safety sheet carefully.

使用本产品前, 请仔细阅读安全说明书。



On your Android™ or iOS device, scan the QR code to download the "JBL One" app.

在你的 Android™ 或 iOS 设备上, 扫描二维码下载“JBL One” app。

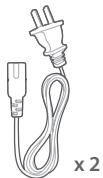
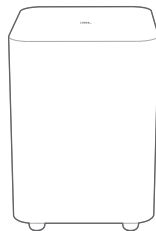

x 2



(1.2 m / 3.9 ft)

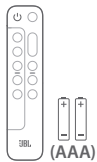

(AAA)



x 2



x 2



x 2



x 2



x 2



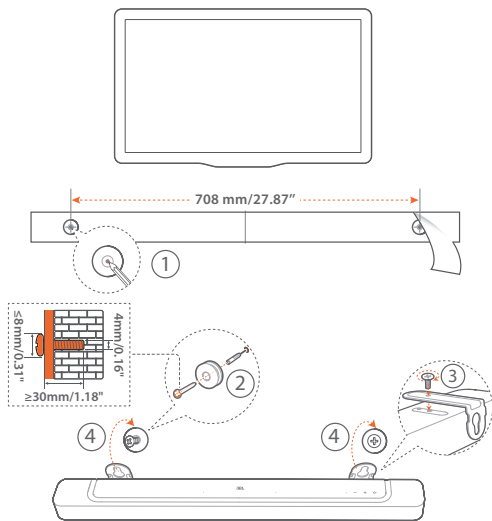
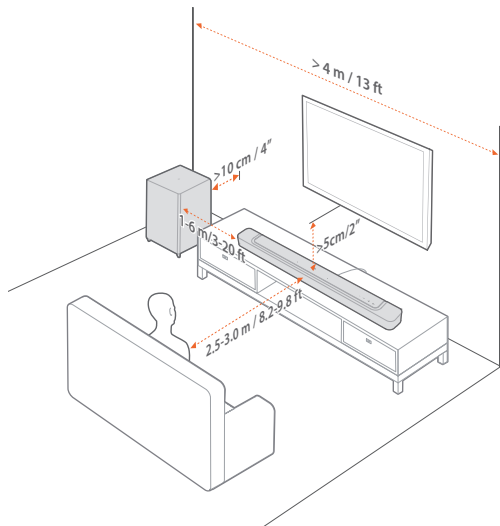



TV (HDMI ARC)

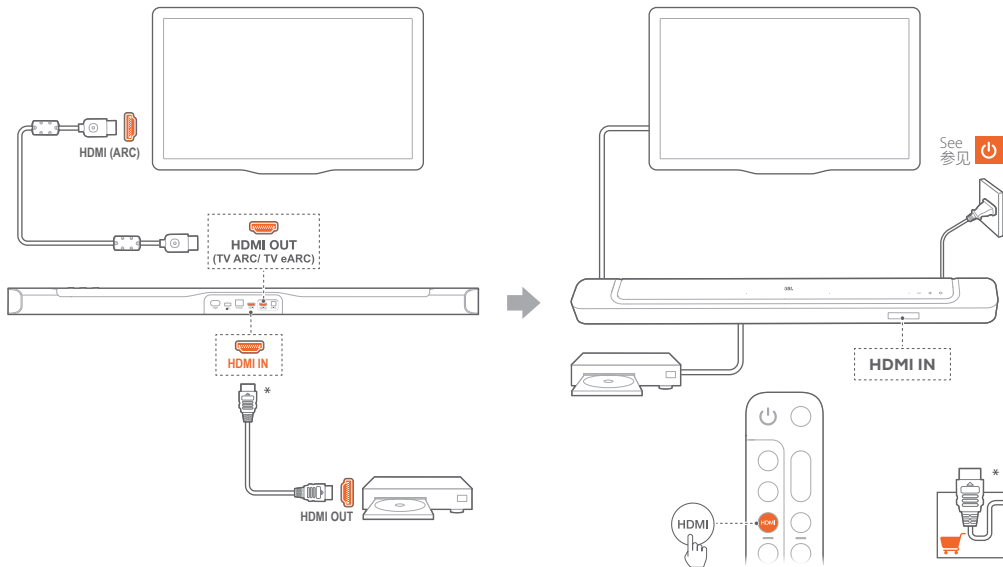



TV (HDMI eARC)

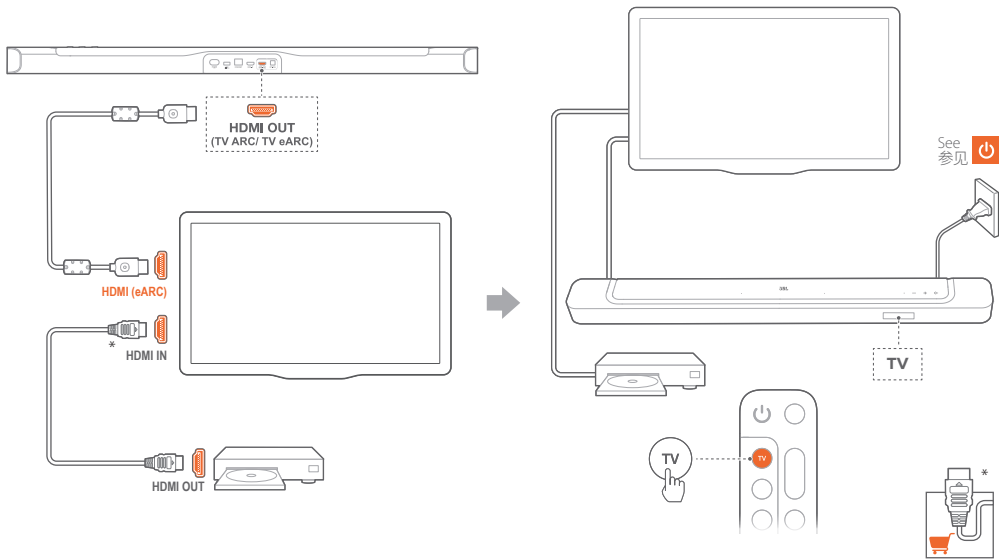

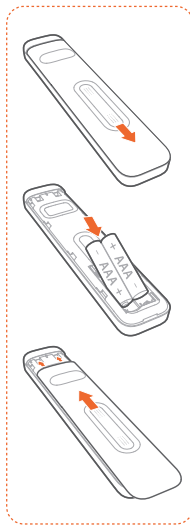
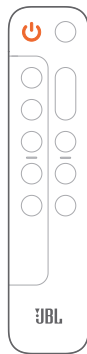
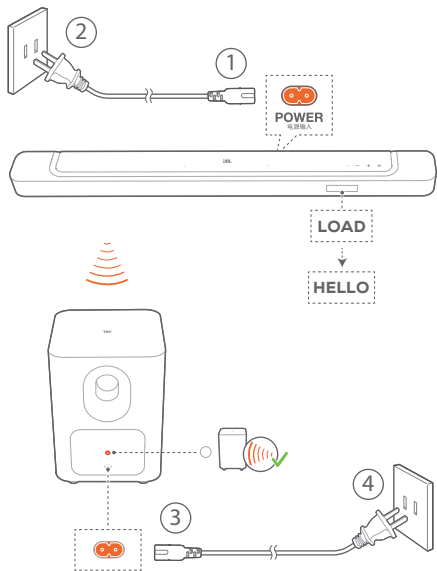



CALIBRATION



PRESS AGAIN TO CONFIRM



CALIBRATING



DONE

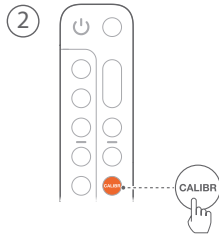
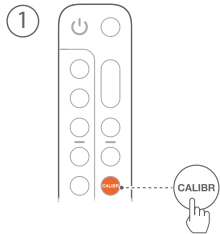

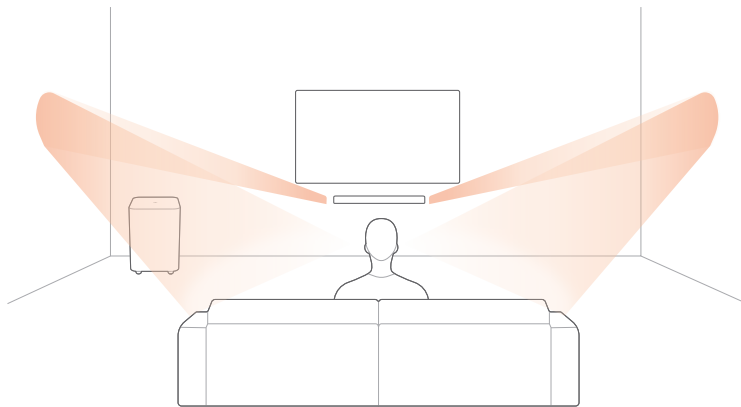

Sound Calibration

Optimize your 3D surround sound experience for your unique listening environment.

声音校准

根据聆听环境优化 3D 环绕声体验。

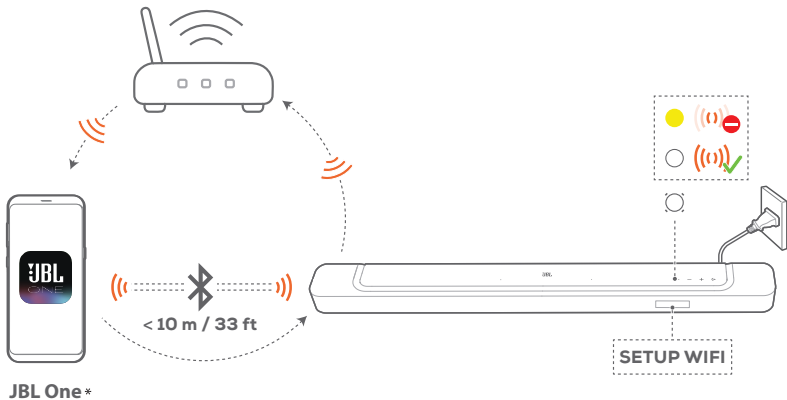

On an Android or iOS device, add the soundbar to your home Wi-Fi network through the JBL One app. Follow the app instructions to complete setup.

* Some features require subscriptions or services not available in all countries.

在 Android 或 iOS 设备上, 通过 JBL One 应用将条形音箱添加到您的家庭 Wi-Fi 网络。按照应用提示完成设置。

* 有些功能需订阅相关服务才能使用, 但并非在所有国家和地区上线。



General specification:

- Model: BAR 500 (soundbar unit)
BAR 500 SUB (subwoofer unit)
- Sound system: 5.1 channel
- Power supply: 100 - 240V AC, ~ 50/60Hz
- Total speaker power output (Max @THD 1%): 590W
- Soundbar output power (Max @THD 1%): 290W
- Subwoofer output power (Max. @THD 1%): 300W
- Soundbar transducer: 4x (46x90)mm racetrack drivers, 3x 0.75" (20mm) tweeters
- Subwoofer transducer: 10" (260mm)
- Networked standby power: < 2.0 W
- Operating temperature: 0 °C - 45 °C

HDMI specification

- HDMI video input: 1
- HDMI video output (with Enhanced Audio Return Channel, eARC): 1
- HDMI HDCP version: 2.3
- HDR pass through: HDR10, Dolby Vision

Audio specification

- Frequency response: 35Hz - 20kHz (-6dB)
- Audio inputs: 1 Optical and Bluetooth

USB specification

- USB port: Type A
- USB rating: 5V DC, 0.5A

Wireless specification

- Bluetooth version: 5.0
- Bluetooth profile: A2DP 1.2, AVRCP 1.5
- Bluetooth transmitter frequency range: 2400 MHz - 2483.5 MHz

- Bluetooth transmitter power: <15 dBm (EIRP)
- Wi-Fi network: IEEE 802.11 a/b/g/n/ac/ax (2.4GHz/5GHz)
- 2.4G Wi-Fi transmitter frequency range: 2412 - 2472 MHz (2.4 GHz ISM Band, USA 11 Channels, Europe and others 13 Channels)
- 2.4G Wi-Fi transmitter power: < 20 dBm (EIRP)
- 5G Wi-Fi transmitter frequency range: 5.15 - 5.35GHz, 5.725 - 5.825GHz
- 5G Wi-Fi transmitter power: 5.15 - 5.25GHz <23dBm, 5.25 - 5.35GHz <20dBm, 5.725 - 5.825GHz <14dBm (EIRP)
- 2.4G wireless transmitter frequency range: 2406 - 2474 MHz
- 2.4G wireless transmitter power: <10 dBm (EIRP)

Dimensions

- Soundbar dimensions (W x H x D): 1017 x 56 x 103.5 mm / 40" x 2.2" x 4"
- Subwoofer dimensions (W x H x D): 305 x 440.4 x 305 mm / 12" x 17.3" x 12"
- Soundbar weight: 2.8kg / 6.2 lbs
- Subwoofer weight: 10 kg / 22 lbs
- Packaging dimensions (W x H x D): 1105 x 370 x 475 mm / 43.5" x 14.6" x 18.7"
- Packaging Weight: 16.2 kg / 35.6 lbs

一般规格:

- 型号: BAR 500 (条形音箱部件)
BAR 500 SUB (低音扬声器部件)
- 音箱系统: 5.1 声道
- 电源: 100 - 240V AC, ~ 50/60Hz
- 扬声器总输出功率 (THD 为 1% 时的最大值): 590W
- 条形音箱输出功率 (THD 为 1% 时的最大值): 290W
- 低音炮输出功率 (THD 为 1% 时的最大值): 300W
- 条形音箱喇叭单元:
4 个 (46x90)mm 跑道型喇叭单元,
3 个 0.75" (20mm) 高音喇叭单元
- 低音炮喇叭单元: 10" (260mm)
- 联网待机功率: < 2.0W
- 工作温度: 0 °C - 45 °C

HDMI 规格

- HDMI 视频输入: 1
- HDMI 视频输出 (带高级音频回传通道, eARC): 1
- HDMI HDCP 版本: 2.3
- HDR 直通: HDR10, Dolby Vision

音频规格

- 频率响应: 35Hz - 20kHz (-6dB)
- 音频输入: 1 个光纤接口、蓝牙

USB 规格

- USB 端口: A 型
- USB 额定电流: 5V DC, 0.5A

无线规格

- 蓝牙版本: 5.0
- 蓝牙配置文件: A2DP 1.2, AVRCP 1.5

- 蓝牙发射器频率范围: 2400MHz - 2483.5MHz
- 蓝牙发射器功率: < 15dBm (EIRP)
- Wi-Fi 网络: IEEE 802.11 a/b/g/n/ac/ax (2.4GHz/5GHz)
- 2.4G Wi-Fi 发射器频率范围: 2412 - 2472MHz (2.4GHz ISM 频段, 美国 11 个频道, 欧洲和其他国家/地区 13 个频道)
- 2.4G Wi-Fi 发射器功率: < 20dBm (EIRP)
- 5G Wi-Fi 发射器频率范围: 5.15 - 5.35GHz, 5.725 - 5.825GHz
- 5G Wi-Fi 发射器功率: 5.15 - 5.25GHz <23dBm, 5.25 - 5.35GHz <20dBm, 5.725 - 5.825GHz <14dBm (EIRP)
- 2.4G 无线发射器频率范围: 2406 - 2474MHz
- 2.4G 无线发射器功率: < 10dBm (EIRP)

尺寸

- 条形音箱尺寸 (宽 x 高 x 厚): 1017 x 56 x 103.5mm / 40" x 2.2" x 4"
- 低音炮尺寸 (宽 x 高 x 厚): 305 x 440.4 x 305mm / 12" x 17.3" x 12"
- 条形音箱重量: 2.8kg / 6.2 lbs
- 低音炮重量: 10kg / 22 lbs
- 包装尺寸 (宽 x 高 x 厚): 1105 x 370 x 475mm / 43.5" x 14.6" x 18.7"
- 包装重量: 16.2kg / 35.6 lbs

This product contains open source software licensed under GPL. For your convenience, the source code and relevant build instruction are also available at https://harman-webpages.s3.amazonaws.com/JBL_BAR_Gen3_package_license_list.htm

Please feel free to contact us at:

Harman Deutschland GmbH

ATT: Open Source, Gregor Krapf-Gunther, Parkring 3

85748 Garching bei Munchen, Germany

or OpenSourceSupport@Harman.com if you have additional question regarding the open source software in the product.



The Bluetooth® word mark and logos are registered trademarks owned by Bluetooth SIG, Inc. and any use of such marks by HARMAN International Industries, Incorporated is under license. Other trademarks and trade names are those of their respective owners.



The terms HDMI, HDMI High-Definition Multimedia Interface, HDMI trade dress and the HDMI Logos are trademarks or registered trademarks of HDMI Licensing Administrator, Inc.



Wi-Fi CERTIFIED 6™ and the Wi-Fi CERTIFIED 6™ Logo are trademarks of Wi-Fi Alliance®.

COMPATIBLE WITH



Dolby, Dolby Vision, Dolby Atmos, and the double-D symbol are registered trademarks of Dolby Laboratories Licensing Corporation. Manufactured under license from Dolby Laboratories. Confidential unpublished works. Copyright © 2012–2021 Dolby Laboratories. All rights reserved.



Use of the Works with Apple badge means that an accessory has been designed to work specifically with the technology identified in the badge and has been certified by the developer to meet Apple performance standards.

Apple, and AirPlay are trademarks of Apple Inc., registered in the U.S. and other countries.

To control this AirPlay 2-enabled speaker, iOS 13.4 or later is required.



QQ音乐是本音响的内容合作伙伴腾讯公司的商业标识或版权形象。

